

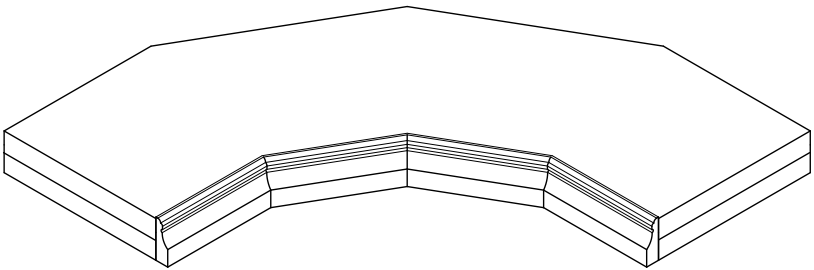

CALIFORNIA REDWOOD WINERACK CORNER BASE AND TRIM

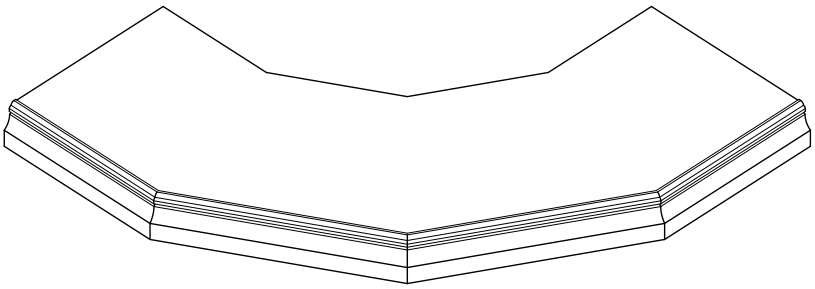

TOOLS AND COMPONENTS

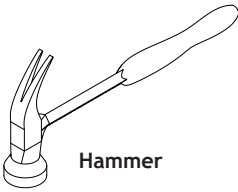

Hammer

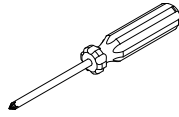

Philips Screwdriver

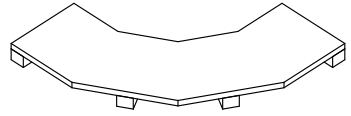

BASE



Nails x 8



7/8" Screws x 8

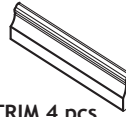

TRIM 4 pcs.

ASSEMBLE RACK TO BASE

ATTACHING RACK TO BASE

To avoid cracking of wood, pre-drill 1/16" holes for screws.
Screw through bottom horizontal bars into BASE* with 7/8" screws or nails (figure A). Shime base to level rack.

Usable as Crown molding

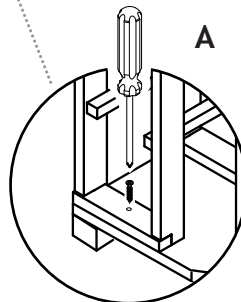
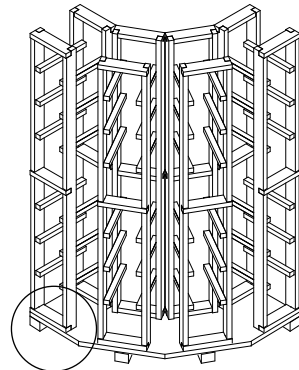
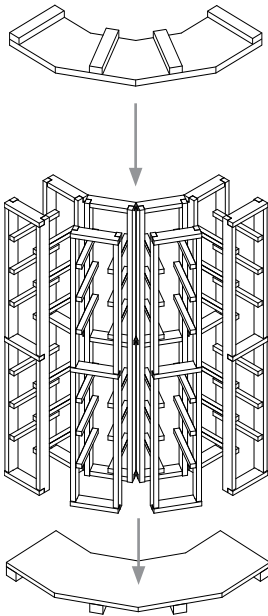

ADD TRIM TO BASE

NAIL IN TRIM

NOTE: The following instructions are for a corner base that will be wrapped around a wall corner. The method of assembly is the same for a corner base going into a corner, trim goes onto the opposite edge.

Nail through TRIM into BASE at groove to hide nails (figure A).

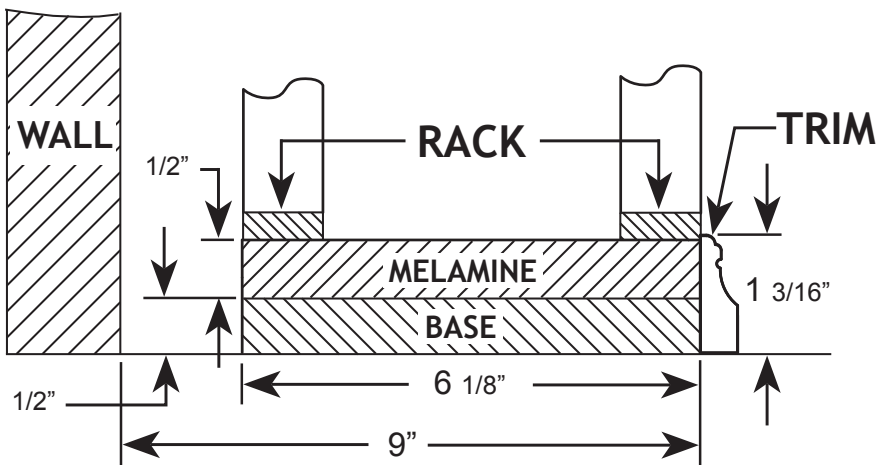
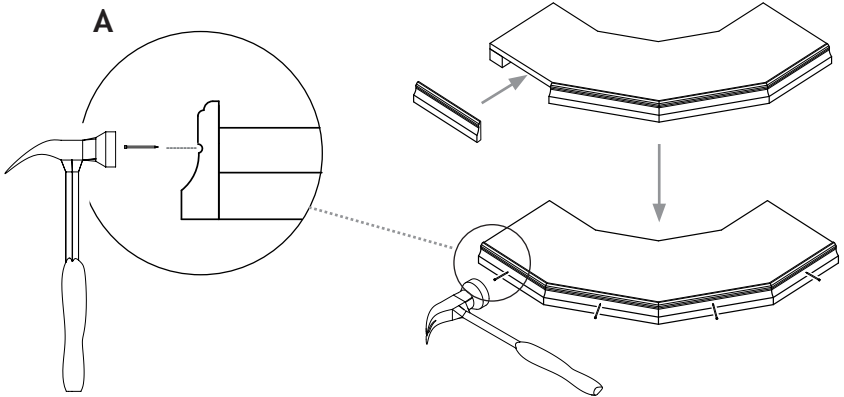

TEST BEFORE USE

Use of WINERACK is strictly at your own risk. Drobot Inc. will not accept any responsibility or liability for damages resulting from units not assembled precisely as directed, or not securely fastened to a wall or support with suitable fasteners.

Before placing any bottles in your WINERACK, test it thoroughly to make sure all fasteners are secure.

LIMITED WARRANTY

Drobot Inc warrants this product to be free from defects due to workmanship or material, under normal use and service, for a period of one (1) year after the date of purchase. Please call our customer service department at 1-888-274-8813 or e-mail us at info@vintagekeeper.com

This warranty does not cover normal cosmetic wear, cosmetic defects, damage resulting from improper assembly or maintenance, shipping damage, accident, or any misuse, abuse or use contrary to the written instructions. This product is not warranted for commercial use.

The warranties expressed above constitute the entire warranty of Drobot Inc with regard to its products and are in lieu of and exclusive of all other warranties, express or implied, including any of merchantability or fitness for a particular purpose. In no event shall Drobot Inc be liable or responsible for incidental or consequential damages, including spoilage or breakage of wine. It is your own responsibility to insure your wine, and to take all reasonable and necessary precautions to safeguard its condition.

© Drobot Inc, 2007